

# THE TURRET

---

## SHALLOW WATER? NO PROBLEM.

A floating water intake device  
for shallow water.

THREE METRE WIDE TURRET  
OVERVIEW

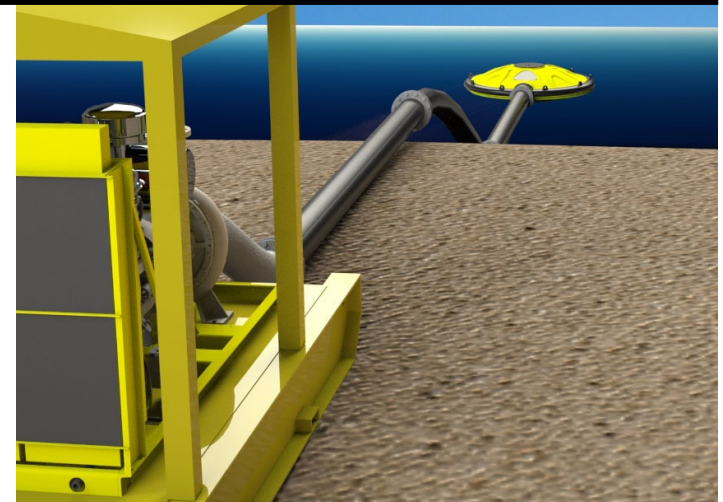
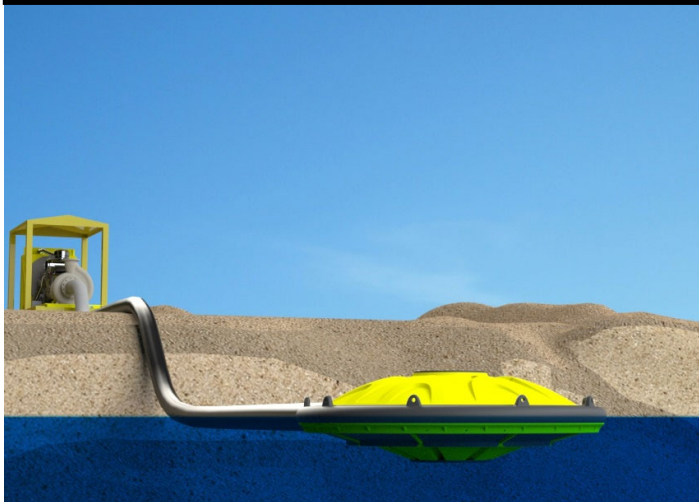

## INTRODUCING THE TURRET

**The Turret is a floating water intake device that solves the problems of vortexing, pump cavitation and drawing from shallow water its patented radial geometric design.**

### SPACE-AGE SHAPE – LEGENDARY PERFORMANCE

The Turret creates a barrier against vortexing and is a water intake solution for dewatering, tailings dams, decant ponds and raw water dams. It is an all-round solution for shallow water bodies:

- **Mobile decanting:** The Turret is a replacement for water intakes on existing decant barges and siphon decant systems. Because it takes water from just under the surface, the Turret permits much shallower decant ponds without the need to change the existing decant structure.
- **Fixed decanting:** When combined with a skid-mounted pump, the Turret is also a land-based, movable, lower capex and safer alternative to fixed decant systems such as cascade decant towers, seepage decant towers and embankment drains.

- **Shallower tailings dams:** The Turret can draw water from a depth of only 400mm. This means tailings dams can be much shallower and have much less surface area. This can result in lower evaporation losses, increased drying of tailings, improved tailings densities and reduced frequency of embankment raises.

### TOUGH, SAFE AND SIMPLE

The Turret is built tough. It is constructed of 10mm thick polyethylene and has been tested in the unforgiving environment of Australia's gold mines. Because of its futuristic design, only the Turret:

- Draws water down to 400mm.
- Creates a barrier against vortexing.
- Can be easily relocated with minimal equipment and human intervention.
- Is scalable – so you can add as many Turrets as you need to the one pump, depending on pump capacity and suction size.

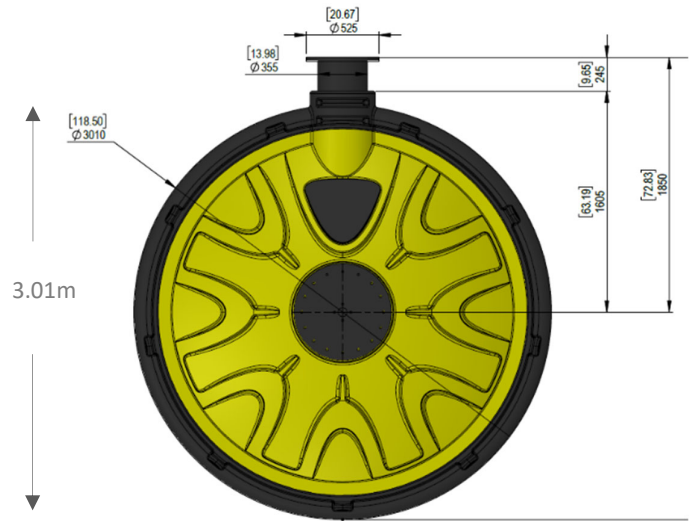
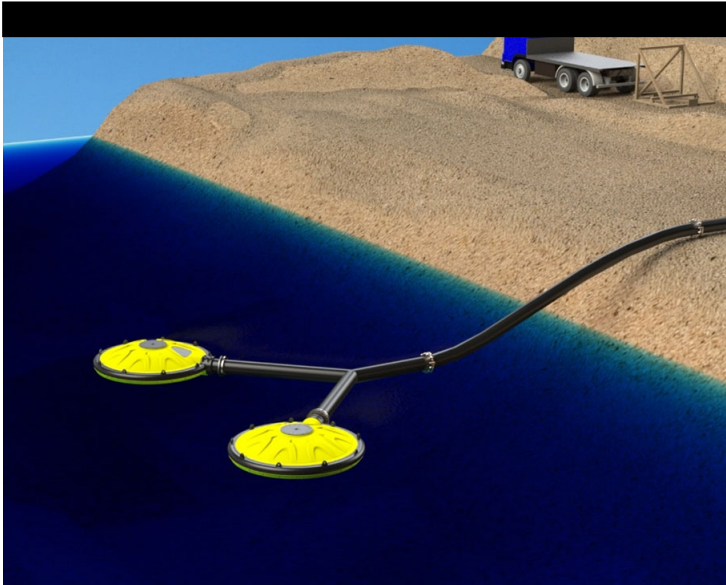

3.01m

## HOW DOES THE TURRET WORK?

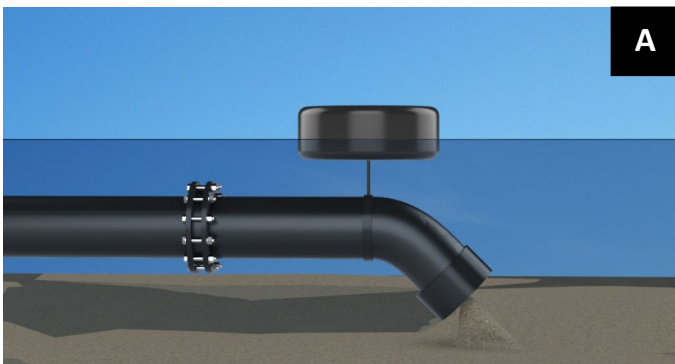

A

### THE GOLDEN RULE

The golden rule is that the pump suction must be:

- Sufficiently above the bottom of a dam to avoid slurry, silt or mud being drawn into the pump, and
- Sufficiently submerged to avoid the formation of vortices on the water surface.

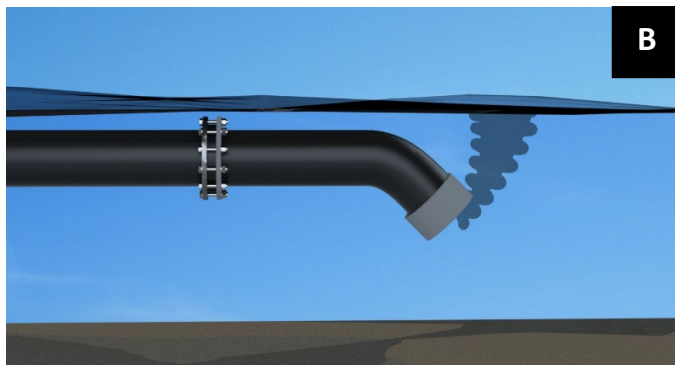

B

The damage that slurry, silt and debris can do to a pump is well known. The damage a vortex can do is more insidious. A vortex causes air to enter the pump through the suction line, which leads to reduced efficiency and may lead to pump damage. A vortex can also cause cavitation damage to pumps.

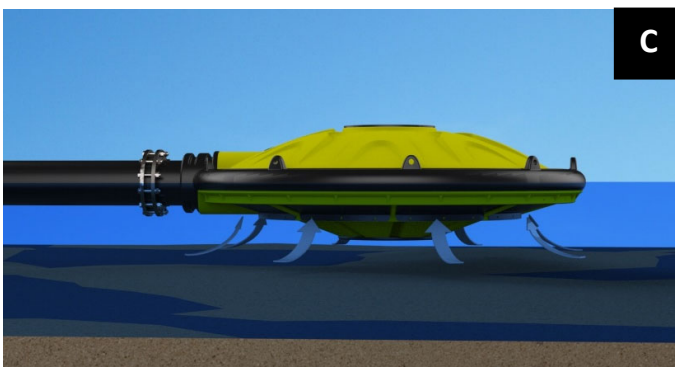

C

#### Figure A:

The pump intake is too low and taking in slurry.

#### Figure B:

The pump intake is too high causing a vortex.

#### Figure C:

The intake is just right because the Turret is sitting on top of the water, taking in water slowly from around the edges of the radial intake.

# THE TURRET ADVANTAGE

**The Turret floats on the surface,  
away from slurry, silt or mud.**

The slow speed of water intake around the wide radial intake means slurry, silt and mud are not stirred up. Taking water from around the surface prevents vortexes forming, damaging pumps and creating downtime.

## RUGGEDNESS WITH PLENTY OF PERFORMANCE

Specification	3m Turret
Diameter	3,010mm (188.5 inches)
Height	871mm (34.3 inches)
Weight (approx.)	489kg (1,078 pounds)
Minimum operational depth	400mm (15.7 inches)
Maximum recommended flow rate	1,000m <sup>3</sup> per hour (588 cubic feet per minute) <sup>1</sup>
Minimum recommended flow rate	400m <sup>3</sup> per hour (235 cubic feet per minute) <sup>2</sup>
Intake pipe diameter	315mm (12.6 inches) OD or 355mm (14.2 inches) OD
Material	10mm (0.39 inch) linear low density polyethylene
Colour	Black and yellow
Construction method	Rotomoulded

<sup>1</sup>The actual recommended flow rate will depend on your system.

<sup>2</sup>The 3m Turret will still operate well below this in clear water, but if there is slurry, silt, mud or particles in the water, these will start to build up on the inside of the bottom of the Turret.

**Are you ready to take charge?  
Then find out more about the Turret advantage today.**

Let us know your NPSH, head height, maximum flow, average flow, pipe size and rating (suction and/or pressure), the fluid you are pumping, the pump design and model, type of pump prime system (vacuum or flood prime), type of pump seal (mechanical or gland) and what you want to achieve from your current systems.

## ENQUIRIES AND ORDERS:

RBH Engineering, 39 Farmers Avenue,  
Boddington, Western Australia 6390  
T: +61 8 9883 8206  
E: robhair@rbhmechanical.com.au

